

Le châssis de type **Standard** est un dispositif d'évacuation naturelle de fumée et de chaleur (DENFC) en façade ouverture intérieur ou extérieur.

- Fenêtre aluminium
- Ouverture et Fermeture type B
- Pneumatique
- Electrique



Equipements en applique

Performances DENFC

Performances selon la norme NF EN12101-2 : 2003 
Conforme selon la norme NFS 619 37 - 1 - 7

Charges éolienne	WI1500
Résistance à la chaleur	B300
Performance réaction au feu	A1
Fiabilité	RE 1000
Température ambiante basse	T(00)

Caractéristiques Techniques

Gamme dimensionnelle (hors cadre)

Angle d'ouverture à 60°	Largeur 520 mm à 1720 mm x Hauteur 520 mm à 1720 mm Largeur 520 mm à 2020 mm x Hauteur 520 mm à 1420 mm
Poids maxi châssis	Electrique : 85 Kg Pneumatique : 110 Kg
Position	Verticale / Inclinée 30°
Remplissage	Polycarbonate alvéolaire Double vitrage isolant Panneau isolant 2 faces tôle alu
Options	Contact de position en feuillure Garde corps, protection chutes des personnes
Finitions	Base : Anodic (<i>contretypage alu satiné</i>) Laqué RAL

Performances AEV, Thermique et Acoustique

Isolation phonique	36 dB
Performance AEV	4 - 9A - C4
Coefficient thermique maxi	1.7 W/m ² K

Ouverture et Fermeture Pneumatique

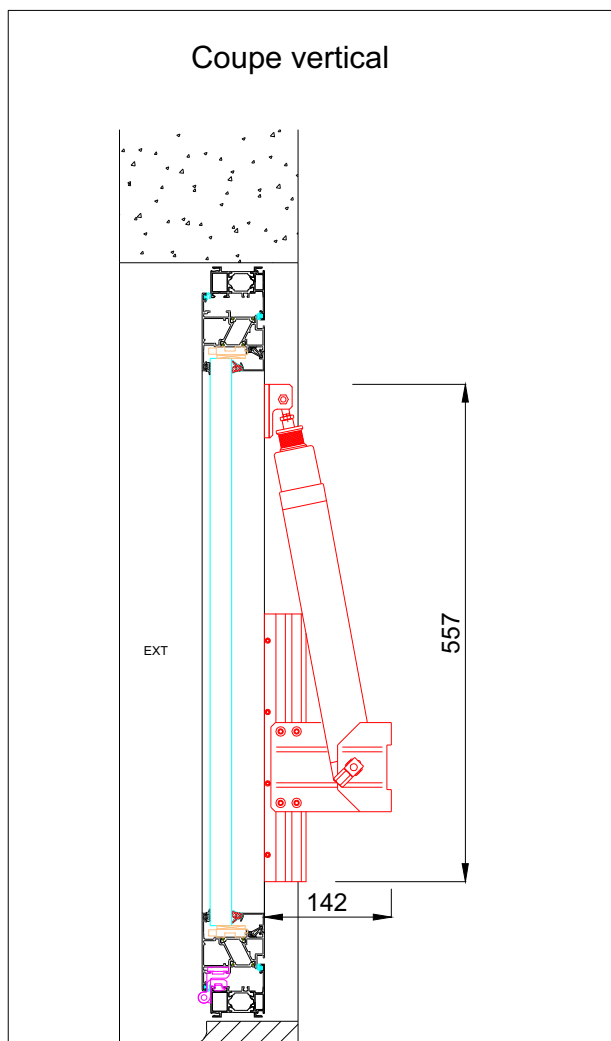

Les Produits

- ▶ Vérins pneumatiques peints à la couleur du châssis
- ▶ Faible encombrement : saillie de 142 mm
- ▶ Freins d'ouverture fermeture intégrés aux vérins
- ▶ Ridoir en tête de vérin pour réglage du bon placage

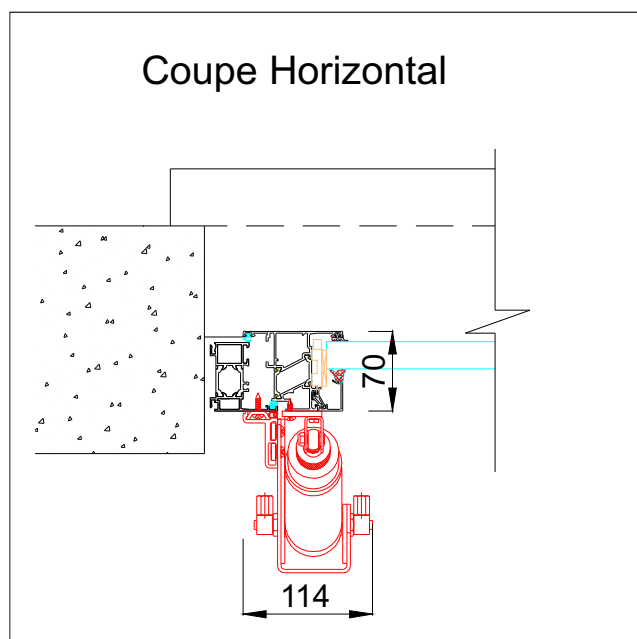

Pose sur façade existante

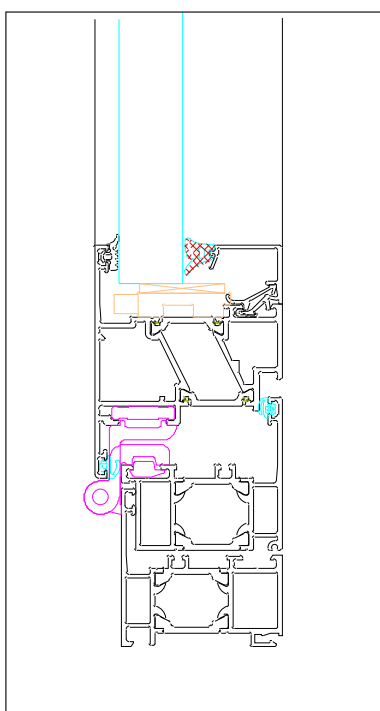
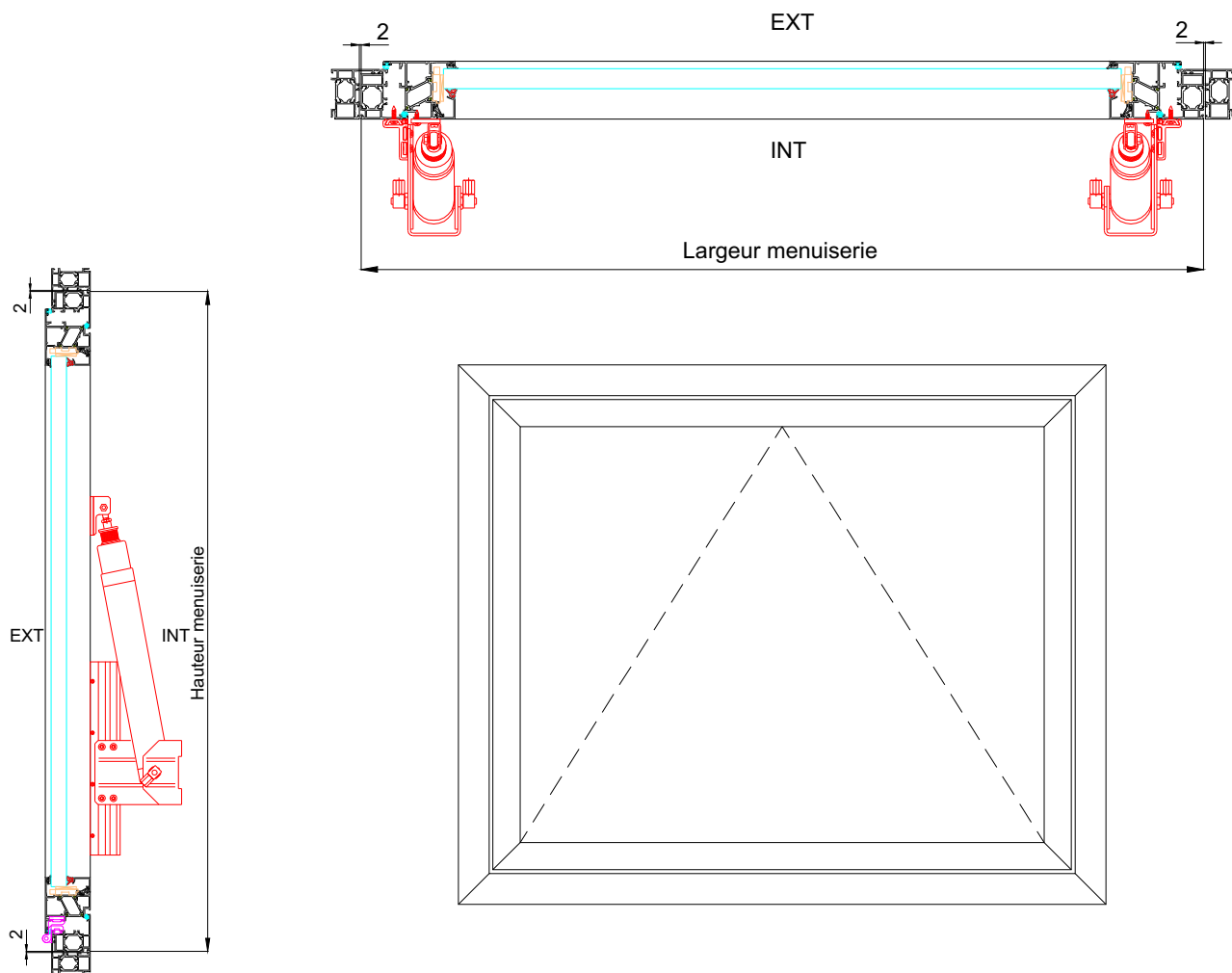

Pose Mur Rideau

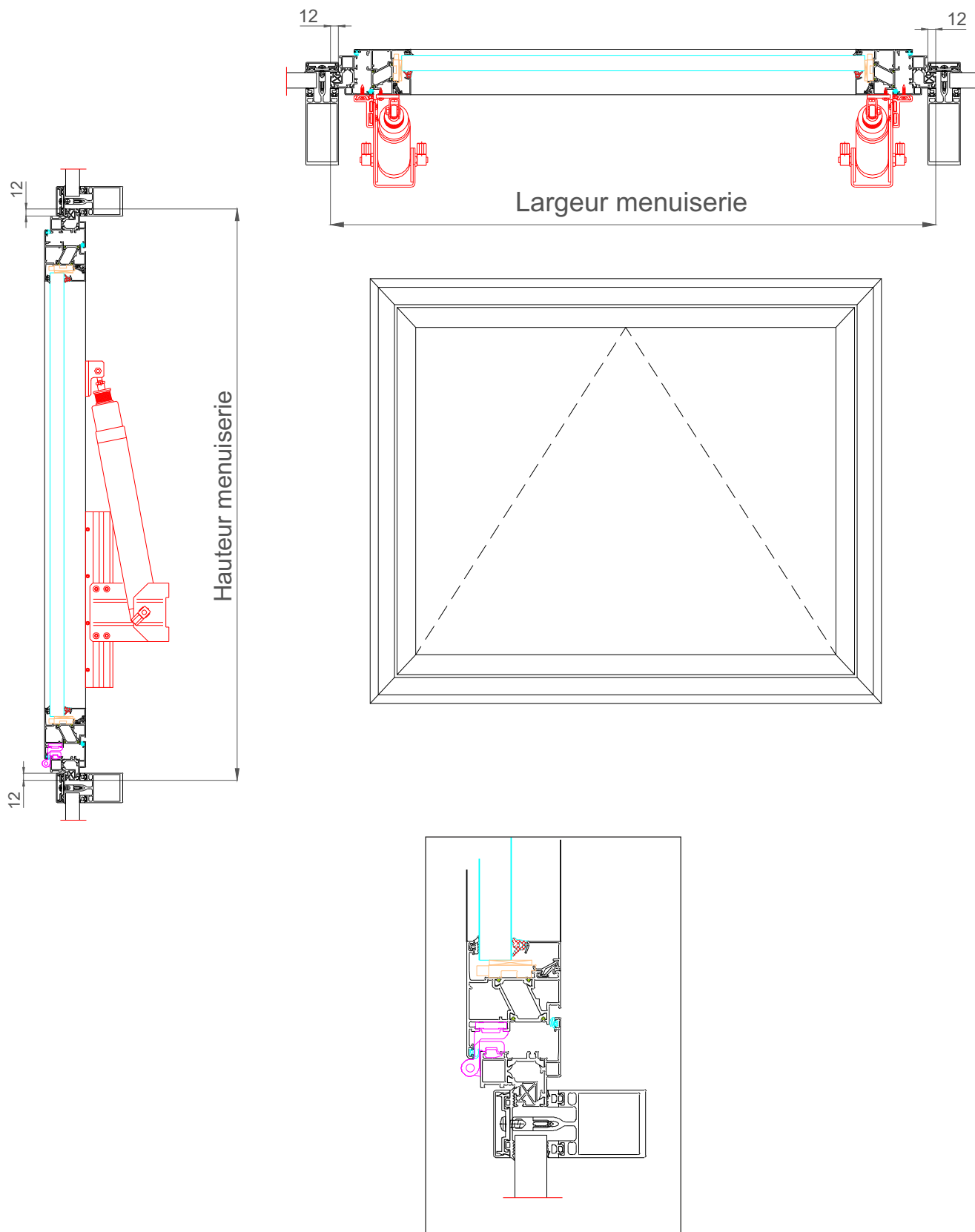

Pose Rénovation

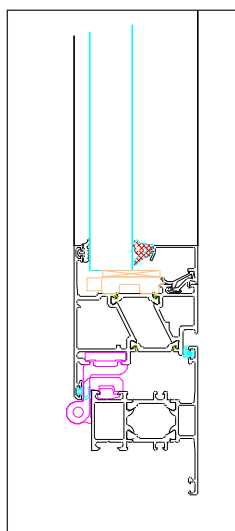
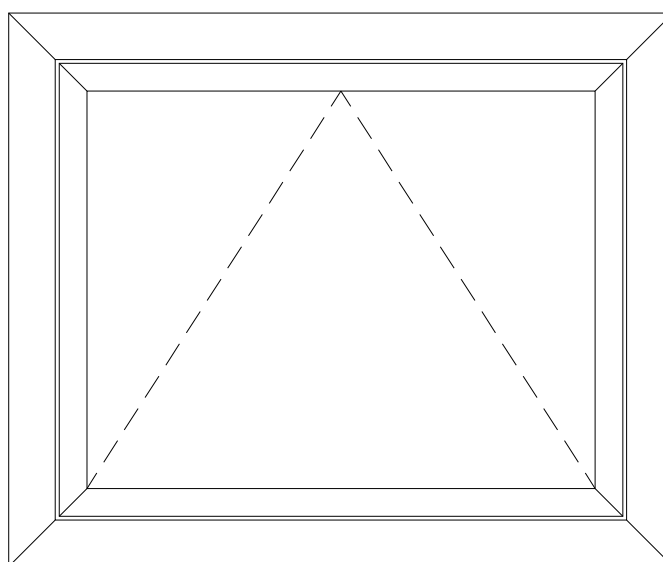
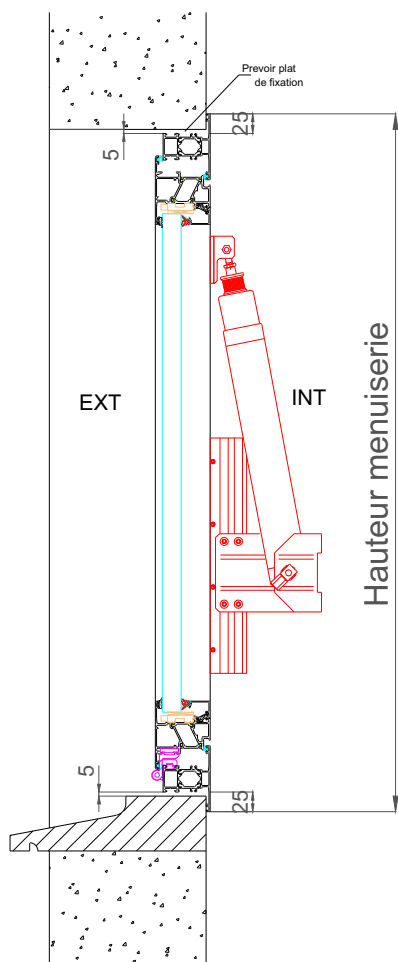
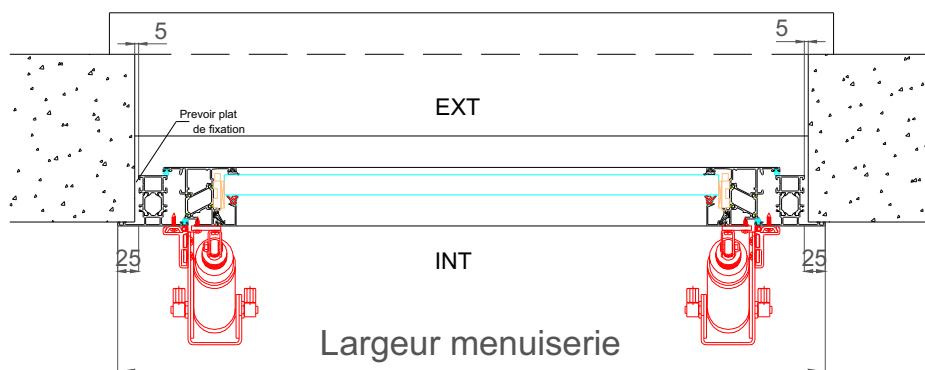

Pose Tableau

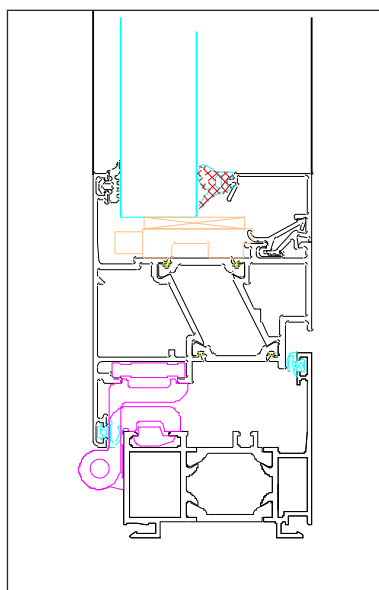
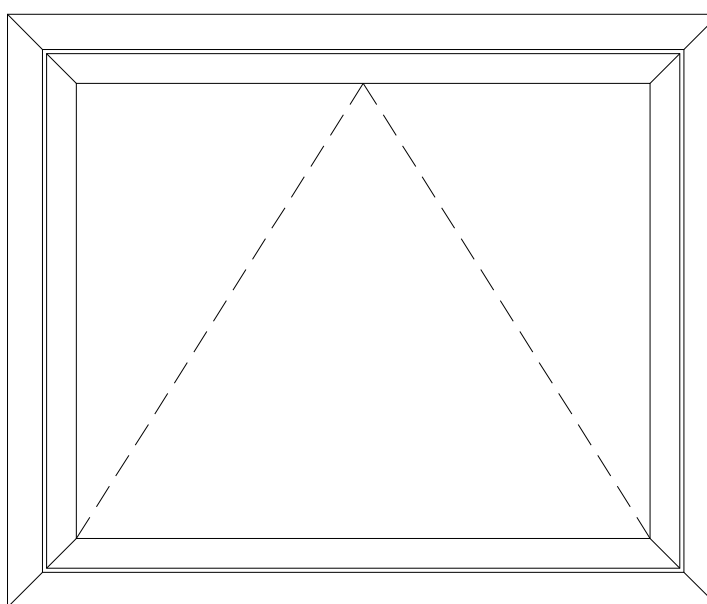
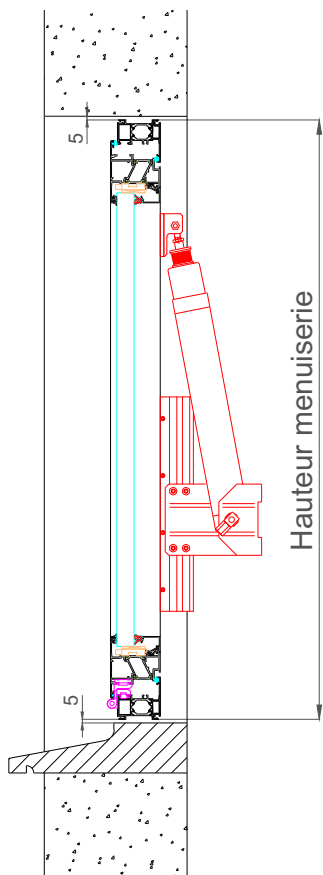
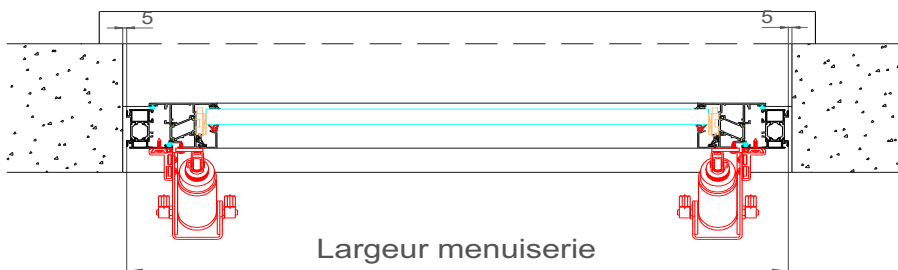

Ouverture et Fermeture Electrique

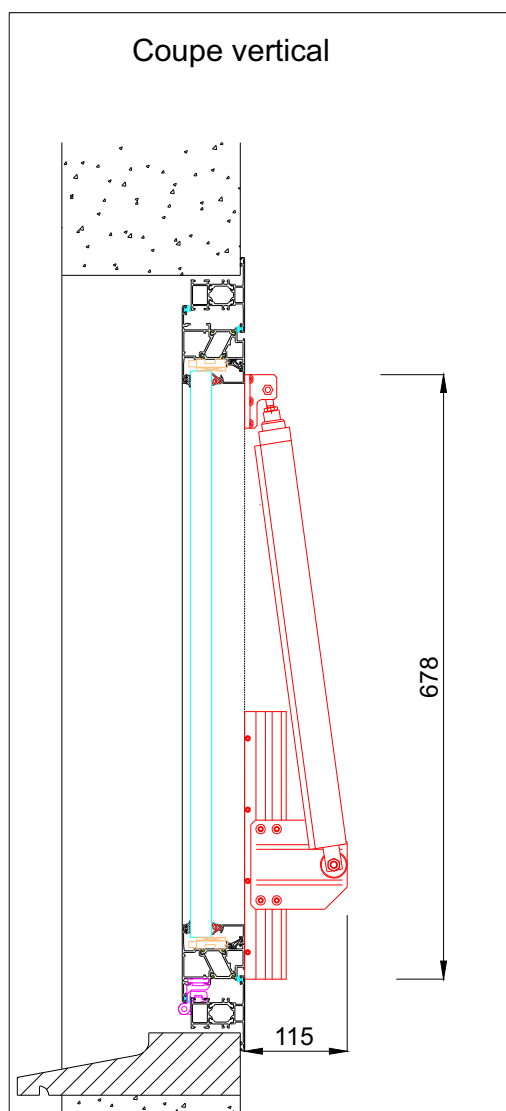

Les Produits

- ▶ Vérins électriques peints à la couleur du châssis
- ▶ Faible encombrement : saillie de 115 mm
- ▶ Module électronique de régulation de l'ouverture et de la fermeture : début de ligne, intermédiaire et fin de ligne
- ▶ Ridoir en tête de vérin pour réglage du bon placage

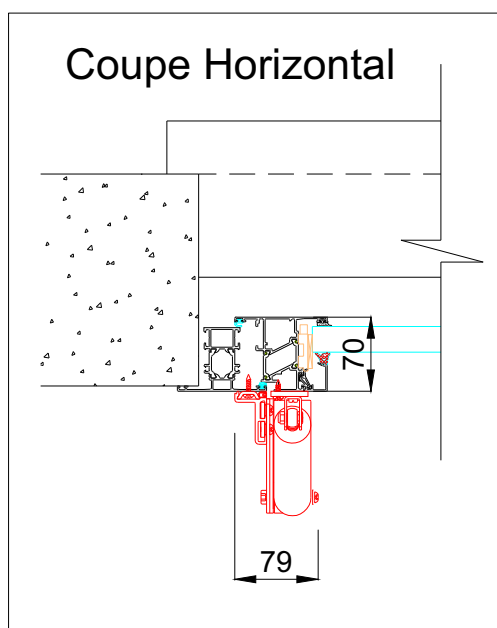

Pose sur façade existante

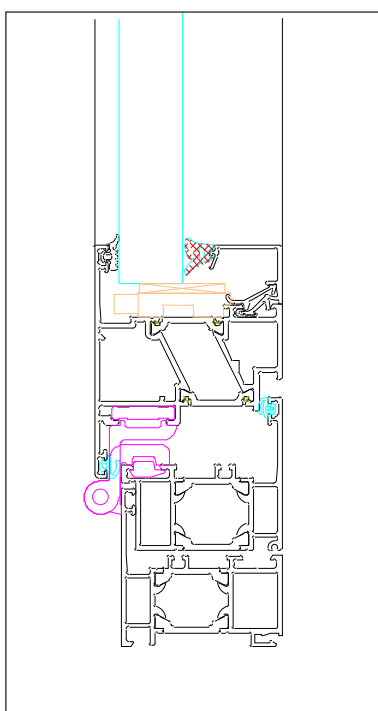
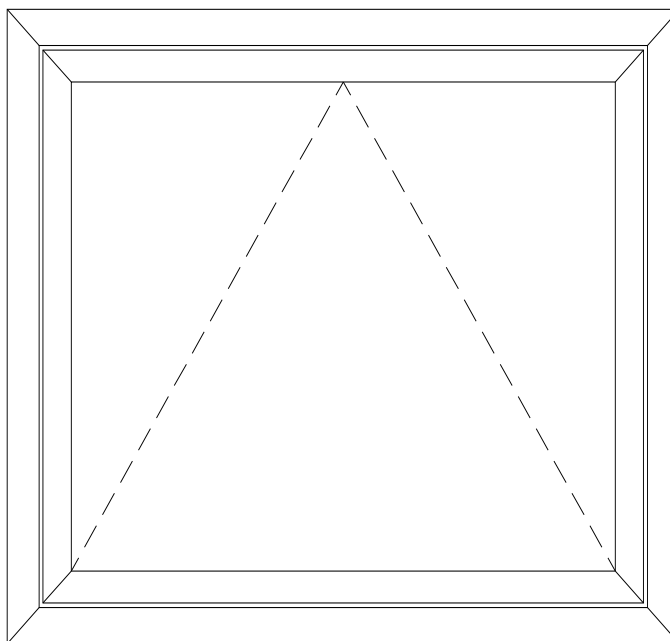
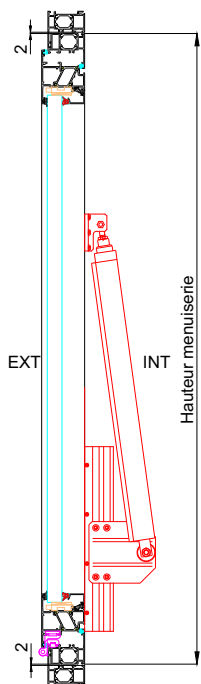
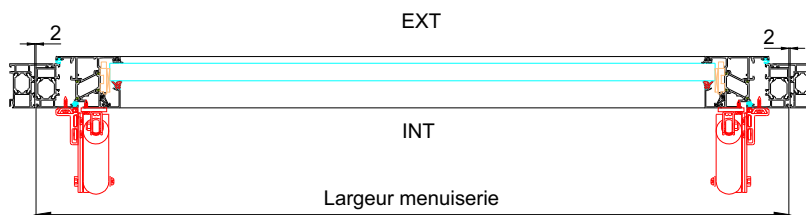

Pose Mur Rideau

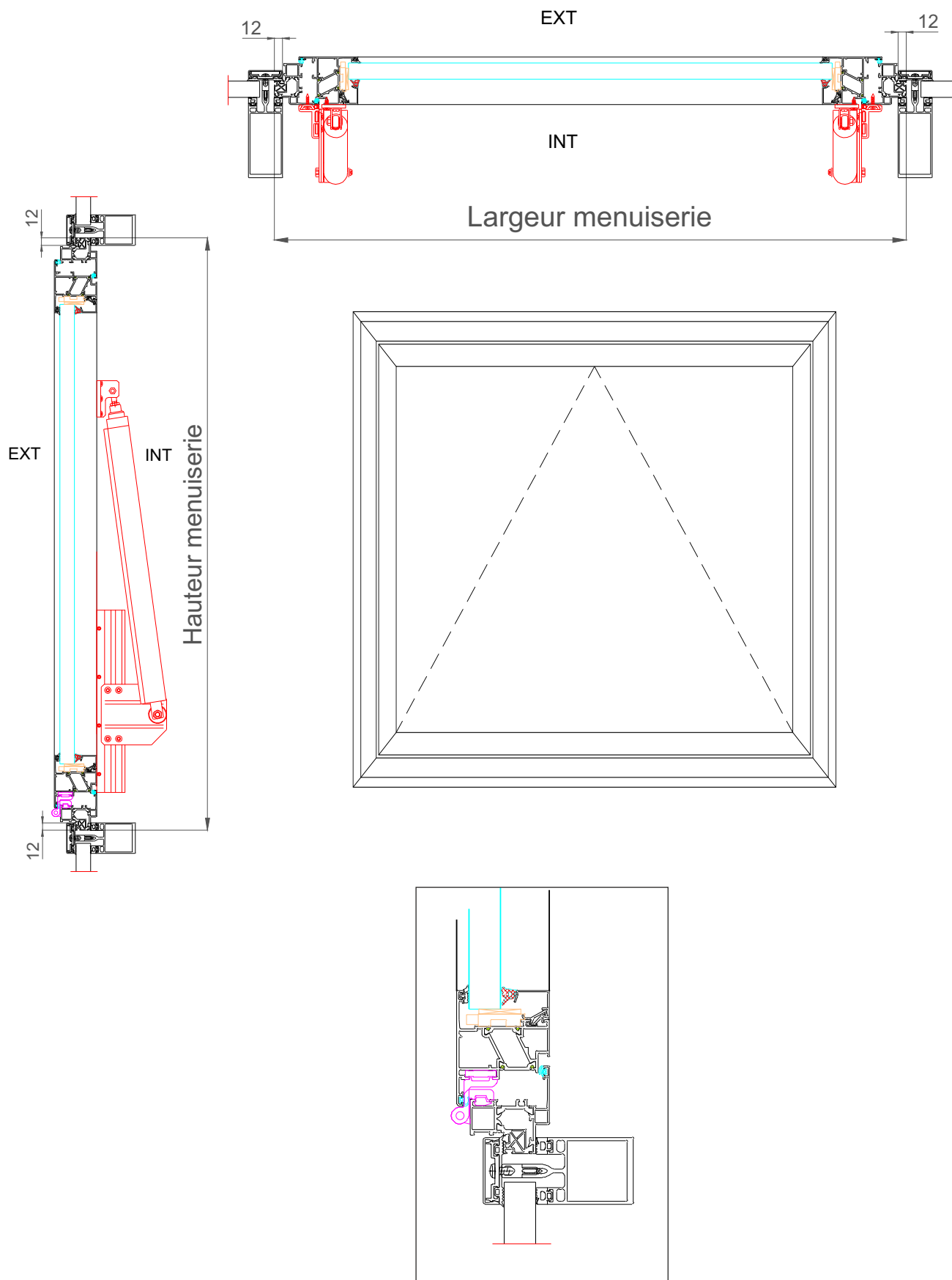

Pose Rénovation

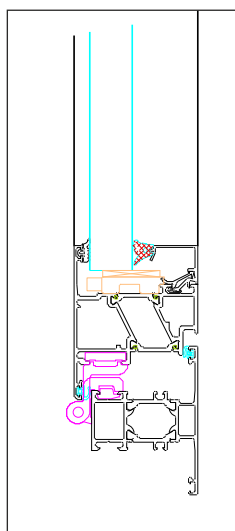
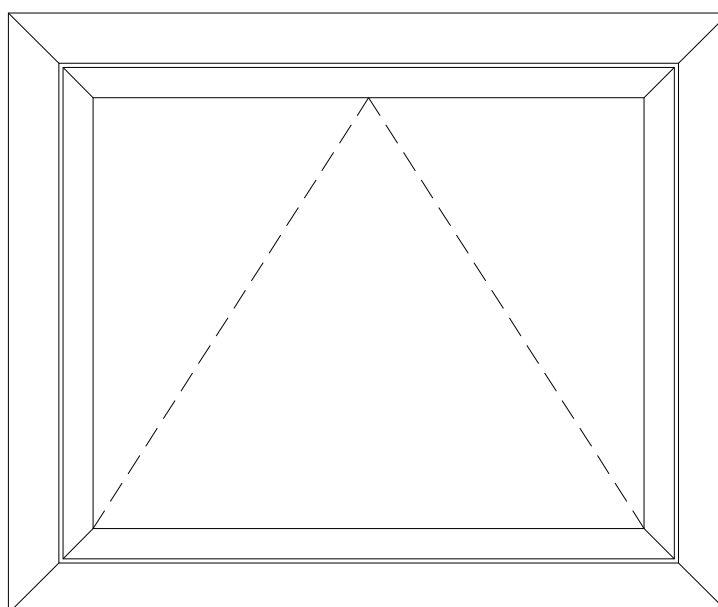
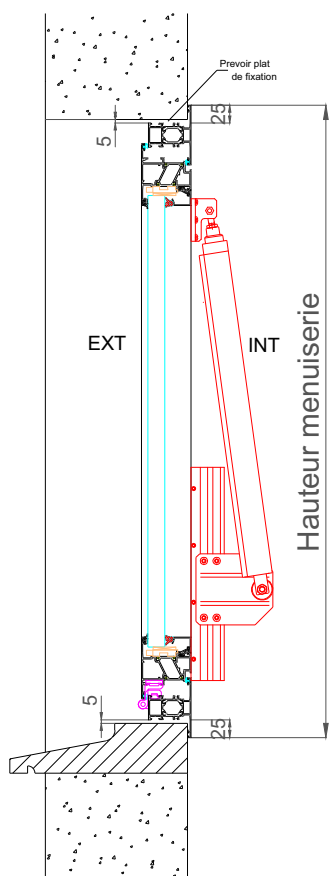
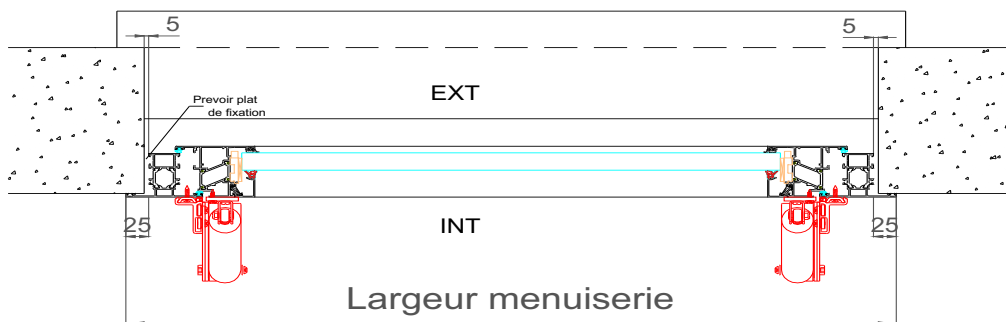

Pose Tableau

